

TECHNICAL DATA

ROLF BENZ KUMIO



**ROLF
BENZ**

- Wooden inner frame
- Spring system: Glass fibrereinforced plastic female connectors

Seating comfort Lounge Deluxe

- Seat made of high-quality cold foam, built up in coordinated layers, covered with a mat consisting of 20 % viscose foam and 80 % microfibres and a non-woven polyester cover.
- Back pad in polyurethane foam
- Back cover quilted underneath with polyester nonwoven
- Upholstery cover glued-on nonwoven polyester
- Down-like backrest cushions comprising compartments with a filling made of 20 % viscose foam and 80 % microfibres.
- Seat height options 43 cm or 46 cm
- Cast feet, metal, Smooth aluminium, powder-coated, matt: optionally:
 - RAL 9017 Traffic black
 - RAL 7022 Umbra grey
 - Marrone metallic

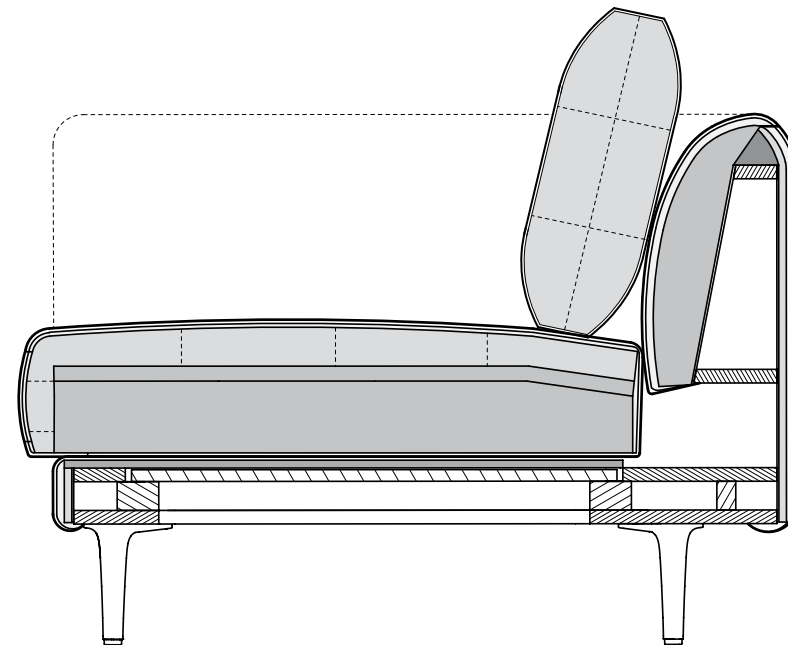

Seat heights available

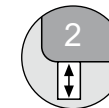

! A high-quality, especially casual upholstery that forms waves/leaves indentations that are typical of the material - this waviness may even occur in new condition. All dimensions are approximate and may deviate by up to around 4 cm, or even more in individual cases where elements are connected.

**ROLF
BENZ**

- Wooden inner frame
- Spring system: Glass fibrereinforced plastic female connectors

Seating comfort Lounge Plus

- Seat made of high quality cold foam with a polyester fleece cover
- Back pad in polyurethane foam
- Back cover quilted underneath with polyester nonwoven
- Upholstery cover glued-on nonwoven polyester
- Down-like backrest cushions comprising compartments with a filling made of 20 % viscose foam and 80 % microfibres
- Cast feet, Smooth aluminium, powder-coated, matt: metal, optionally:
 - RAL 9017 Traffic black
 - RAL 7022 Umbra grey
 - Marrone metallic

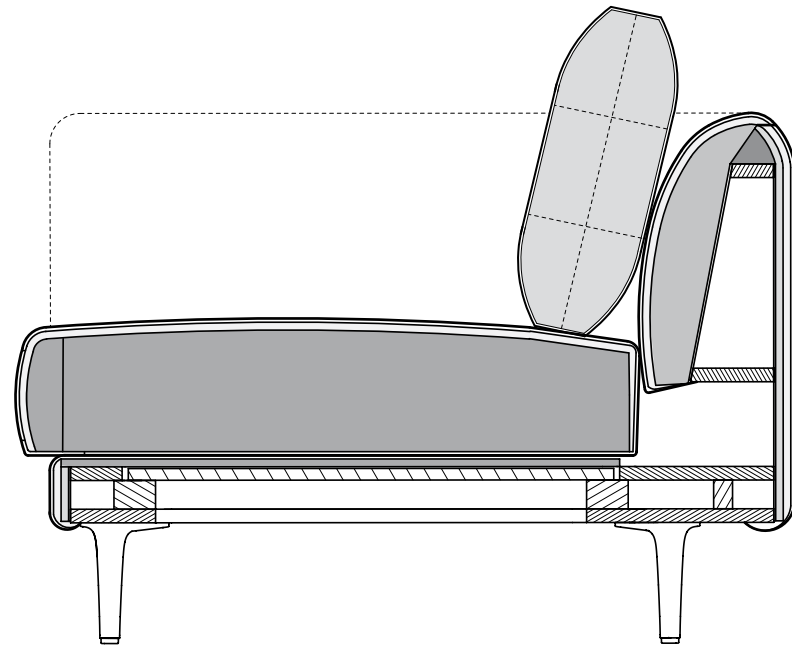

Seat heights available

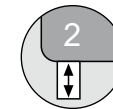

! A high-quality, especially casual upholstery that forms waves/leaves indentations that are typical of the material - this waviness may even occur in new condition. All dimensions are approximate and may deviate by up to around 4 cm, or even more in individual cases where elements are connected.

**ROLF
BENZ**

Sectional sofa round*

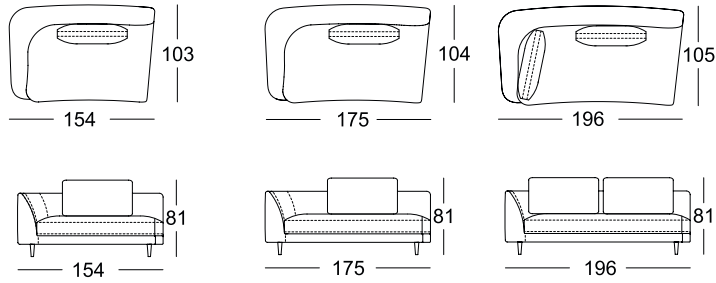

Outsize sectional sofa round*

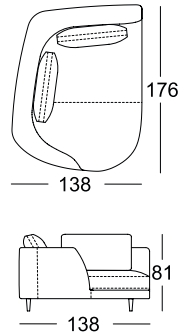

Closing chair with fixed footstool round*

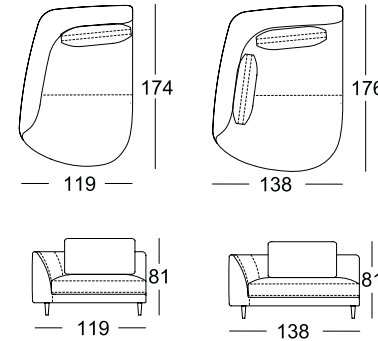

Corner modular sofa element round*

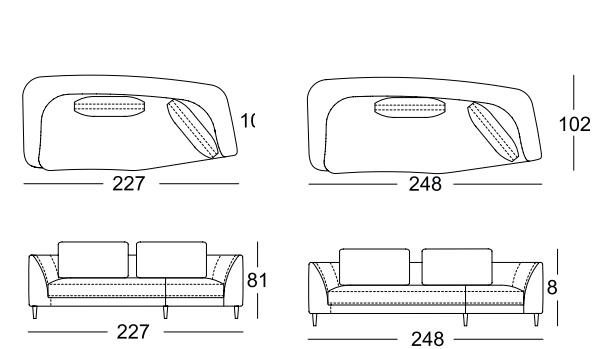

Corner sectional sofa round*

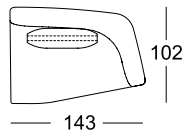

Corner sectional sofa „V“-shaped

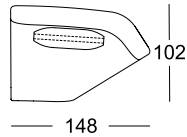

Sectional sofa with fixed footstool round*

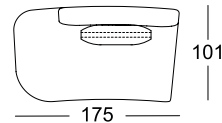

Sectional sofa

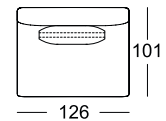

Sectional sofa round

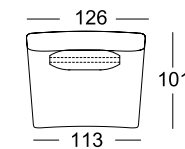
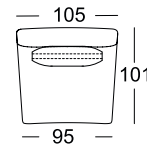

Sectional upholstery bench element

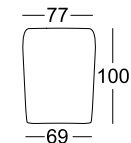

Upholstery bench

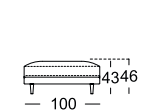
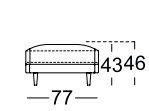
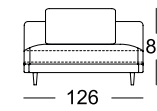
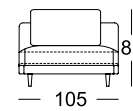
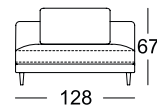
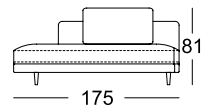
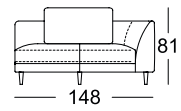
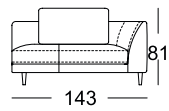
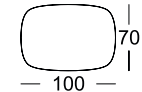

*These elements are only shown in the left version. They are also available in the right version.

Back cushion with
rol

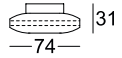

Low back
cushion

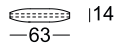

Back cushiion

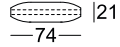

Back cushion
mat

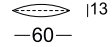

Shelf

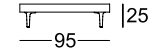
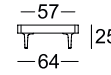
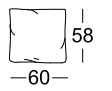
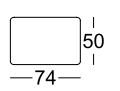
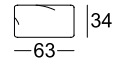
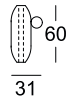
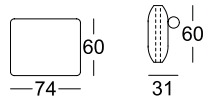
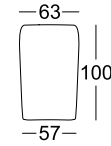

Combination examples:

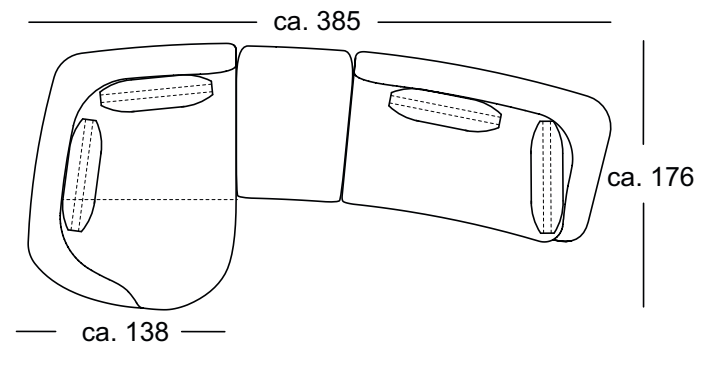
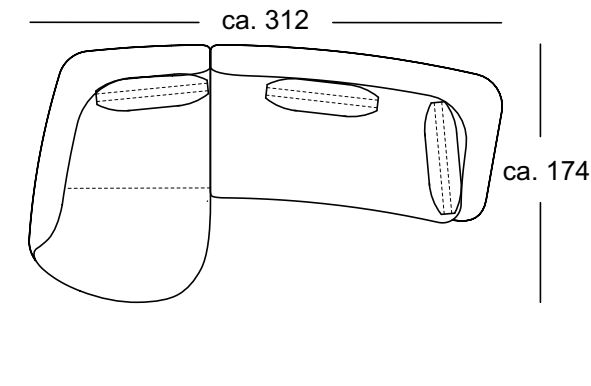
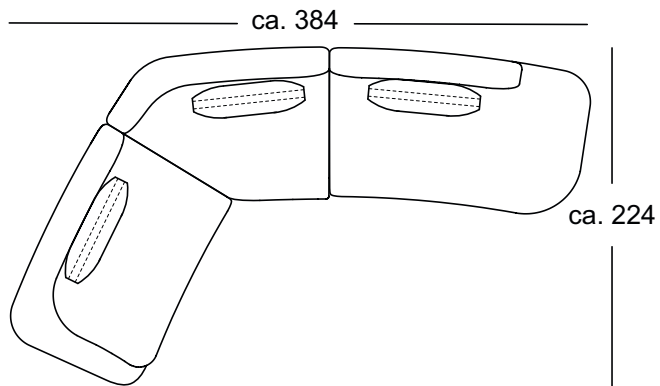

K-ASO-R 555/154 le
K-E-ARB-V 555/148 ri
K-ARB-PSZ-R 555/175 ri
RUK 555/74 x 50 3x

K-ASS-PSZ-R 555/119 le
K-ASO-R 555/196 ri
RUK 555/74 x 50 3x

K-XL-ASO-R 555/138 le
A-PB 555/77
K-ASO-R 555/175 ri
RUK 555/74 x 50 4x

**ROLF
BENZ**