

TECHNICAL DATA

# ROLF BENZ MIOKO

---



**ROLF  
BENZ**

- Cast legs, metal, optionally: Fine-grain aluminium, powdercoated, matt:
  - RAL 9017 Traffic black
  - RAL 7022 Umbra grey
  - Marrone metallic
  - RAL 5004 Black blue
  - RAL 7003 Moss grey
  - RAL 8002 Signal brown
  - RAL 7044 Silk grey
  - Polished
- Steel brace, optionally: Steel, fine structure, powdercoated, matt:
  - RAL 9017 Traffic black
  - RAL 7022 Umbra grey
  - Marrone metallic
  - RAL 5004 Black blue
  - RAL 7003 Moss grey
  - RAL 8002 Signal brown
  - RAL 7044 Silk grey
  - Polished chrome
- Seat heights optionally 43 cm or 46 cm

Cast leg



Steel



- Wood inner frame
- Steel shaft spring system
- Seat made of high-quality cold foam, covered with a down-like pad comprising compartments with a filling made of 90 % foam rods and 10 % polyester fibres (Lounge)
- Seat built up in layers with polyurethane foam and a high-quality cold foam, coordinated in different heights and hardnesses, with a polyester fleece covering (Classic)
- Backrest made of polyurethane foam
- Backrest cover quilted with polyester fleece
- Down-like backrest cushions comprising compartments with a filling made of 80 % foam rods and 20 % polyester fibres

Lounge

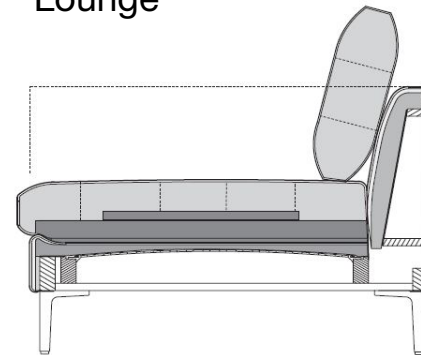

Classic

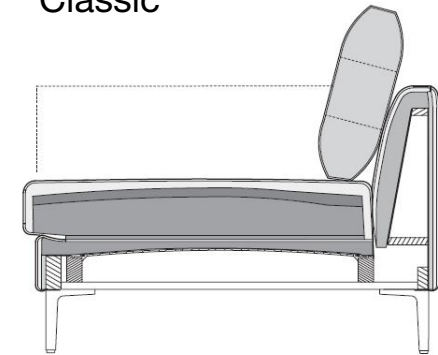

**MIOKO Classic:**

- High-quality, casual upholstery that forms waves/leaves indentations that are typical of the material. All measurements are approximate.

**MIOKO Lounge:**

A high-quality, especially casual upholstery that forms waves/leaves indentations that are typical of the material - this waviness may even occur in new condition. All measurements are approximate.

# Backrest cushion with a gap

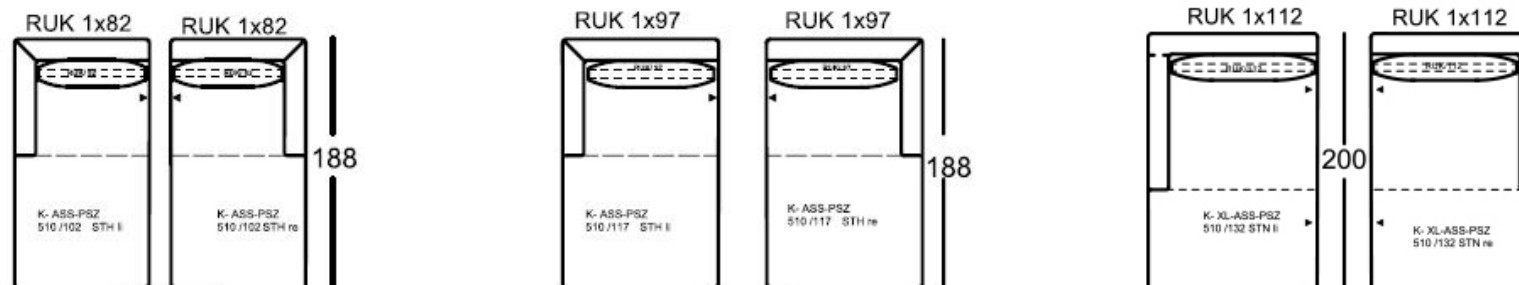
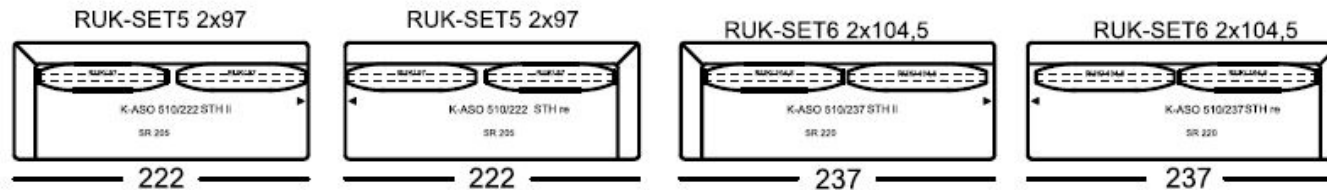
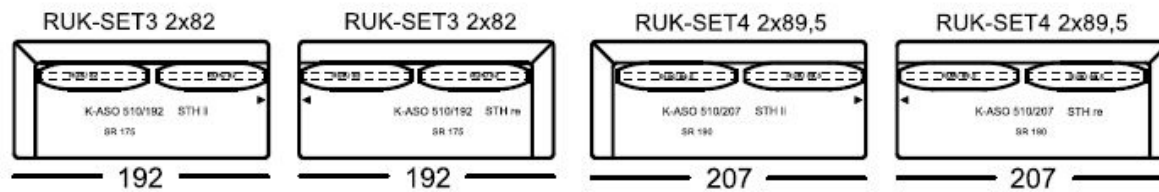
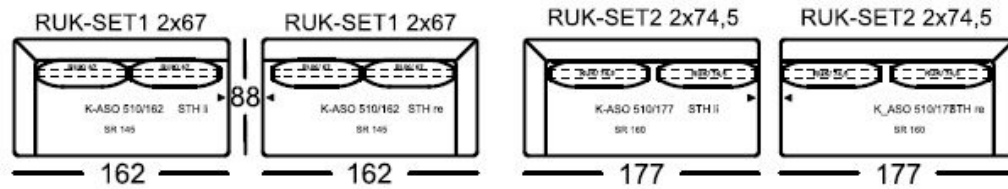
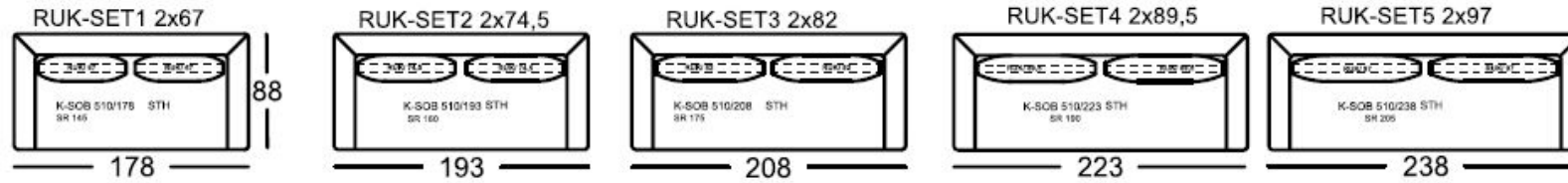

RUK-SET8 2x67 1x59,5

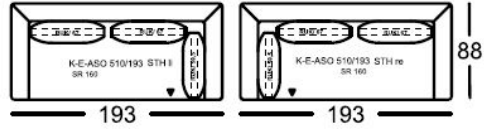

RUK-SET10 2x74,5 1x59,5

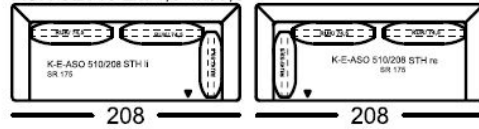

RUK-SET12 2x82 1x59,5

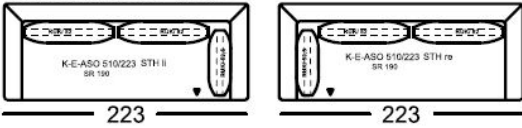

RUK-SET14 2x89,5 1x59,5



RUK-SET16 3x59,5

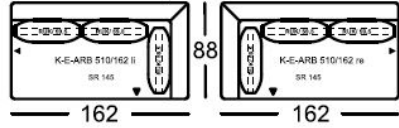

RUK-SET8 2x67 1x59,5

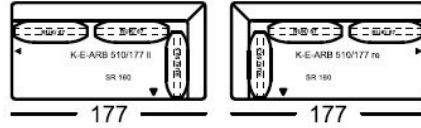

RUK-SET10 2x74,5 1x59,5

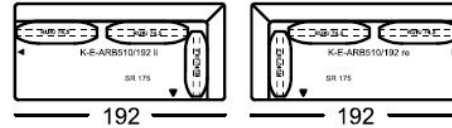

RUK-SET12 2x82 1x59,5

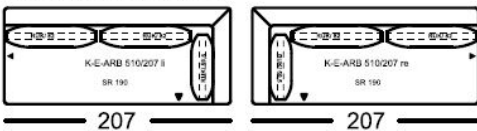

RUK-SET14 2x89,5 1x59,5

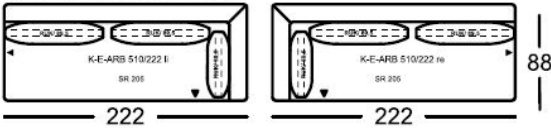

RUK-SET31 2x97 1x59,5

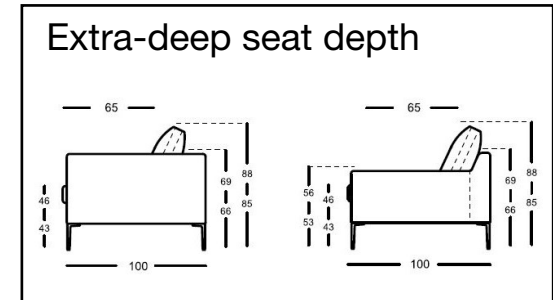
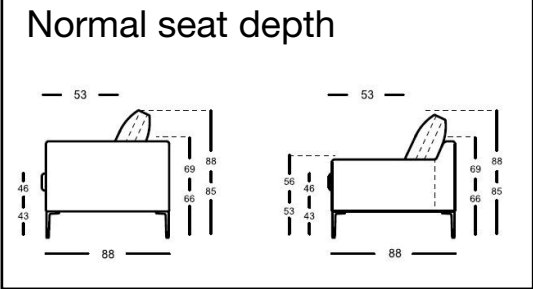
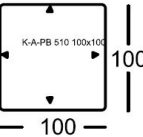
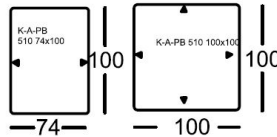
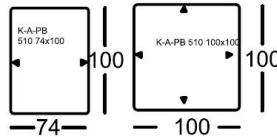
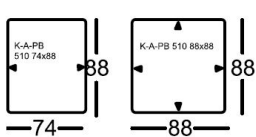
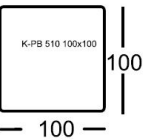
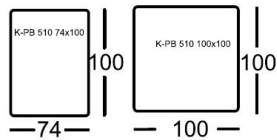
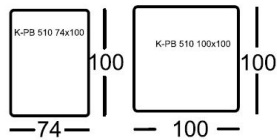
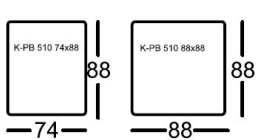
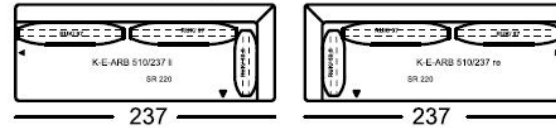

**ROLF  
BENZ**

# Backrest cushion without a gap

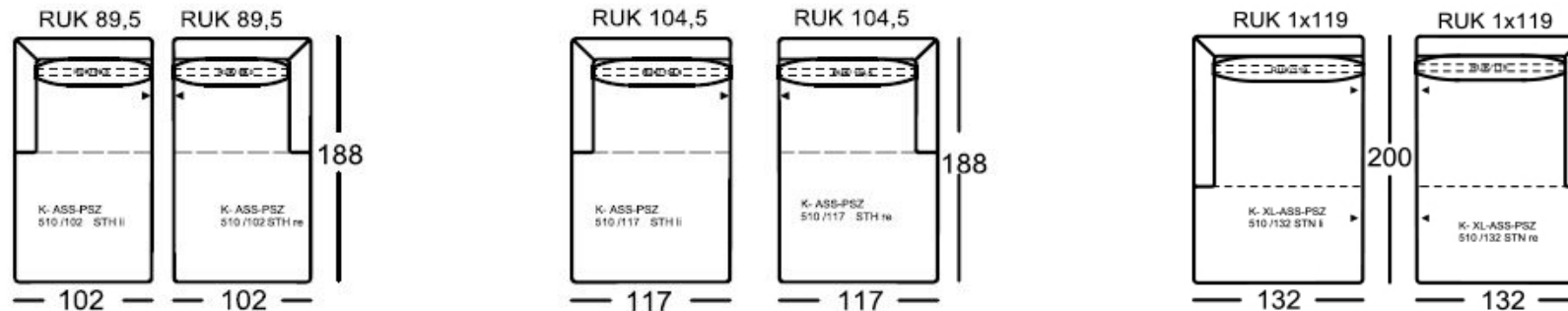
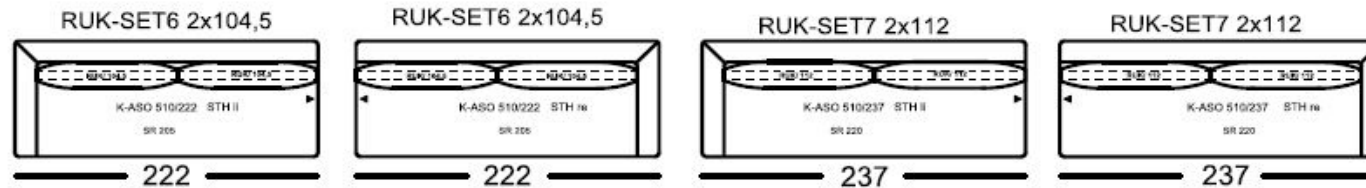
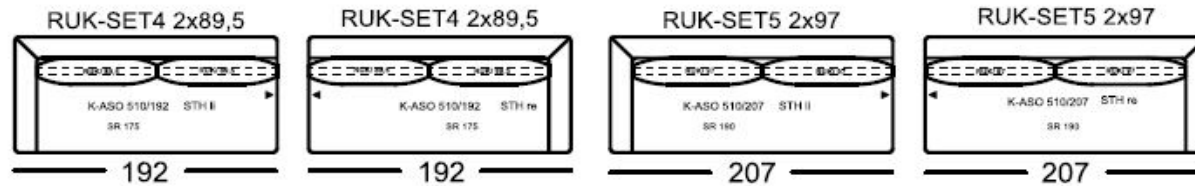
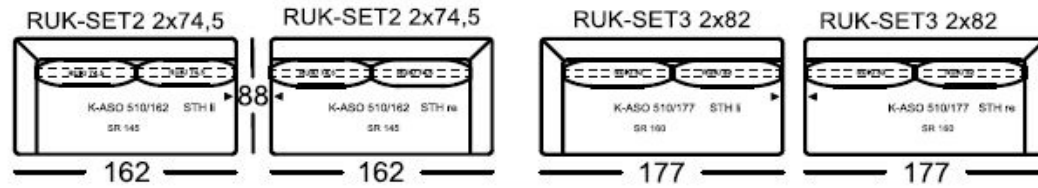
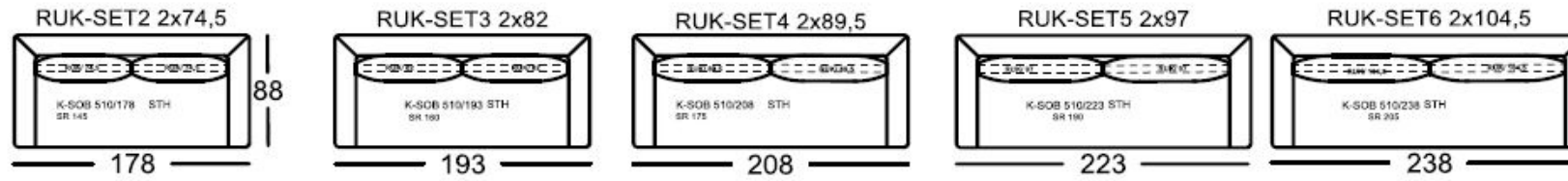

RUK-SET9 2x74,5 1x67

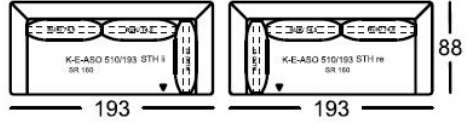

RUK-SET11 2x82 1x67

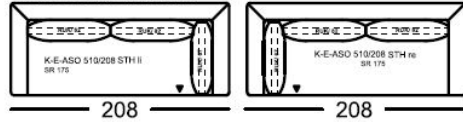

RUK-SET13 2x89,5 1x67

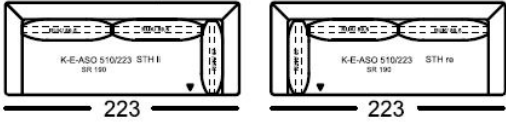

RUK-SET15 2x97 1x67

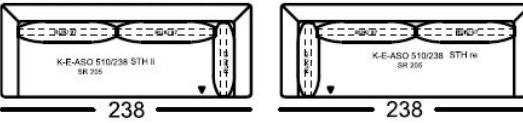

RUK-SET17 3x67

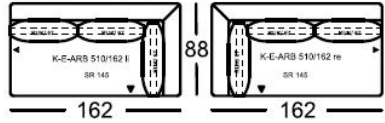

RUK-SET9 2x74 1x67

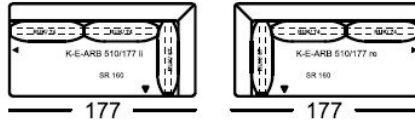

RUK-SET11 2x82 1x67

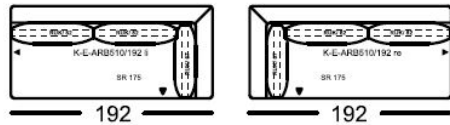

RUK-SET13 2x89,5 1x67

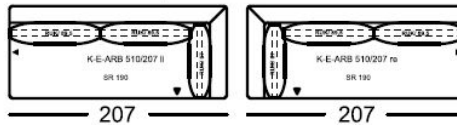

RUK-SET15 2x97 1x67

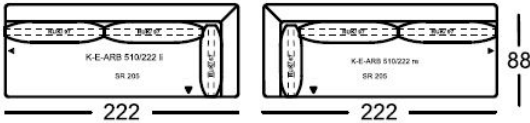

RUK-SET30 2x104,5 1x67

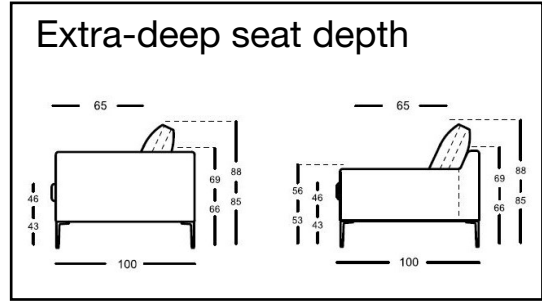
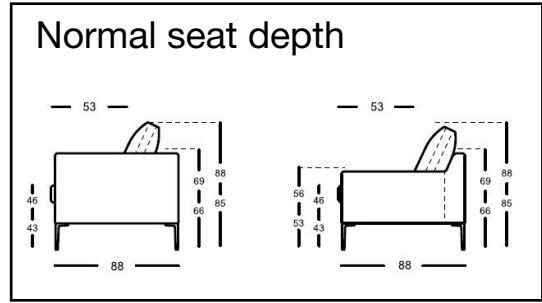
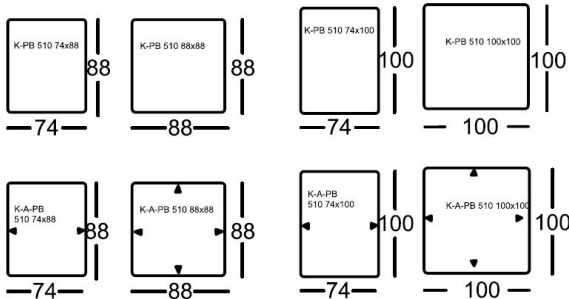
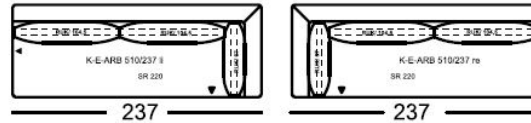

**ROLF  
BENZ**

# Combination examples

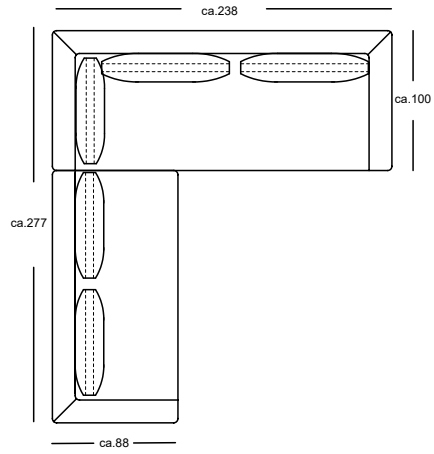

K-ASO 510/177 ISTH i  
RUK-SET2 2x74,5

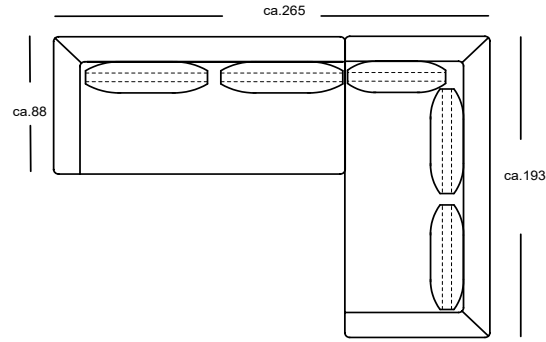

K-ASO 510/177 STH RUK-SET2 2x74,5

K-E-ASO 510/193 STH re RUK-SET8 2x67 1x59,5

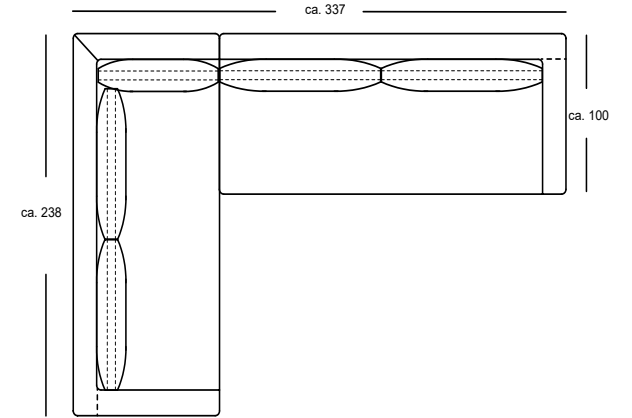

K-UE-E-ASO 510/238STN II RUK-SET25 2x97 1x82

K-UE-ASO 510/237 STN II RUK-SET7 2x112

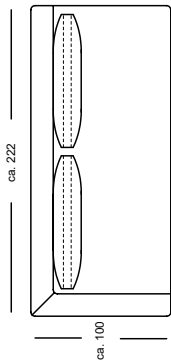
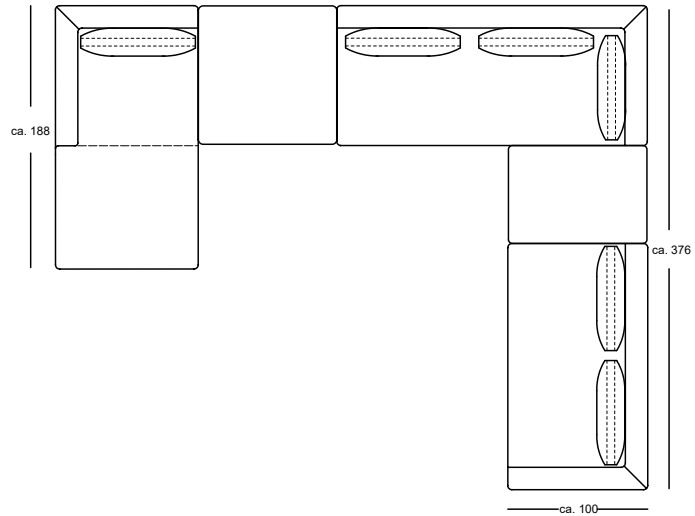

UE-ASO 510/222 STH re

UE- ASS-PSZ 510 /102 STH A-PB 510 99x99 UE-E-ARB 10/222 II A-PB 510 70x99 UE-ASO 510/177 STH re RUK-SETs mit Abstand